

Masterstudium
Raum and Informationsdesign

WS '15-'16
INNO/EXPO
Innovation Ausstellen





Projekt:
INNO EXPO, WS 15/16
Bereit zum Absprung
Anja Huber



Projekt:
INNO EXPO, WS 15/16
Bereit zum Absprung
Anja Huber



Projekt:
INNO EXPO, WS 15/16
Natürlich... weiß
Lena Kasten



Projekt:
INNO EXPO, WS 15/16
Natürlich... weiß
Lena Kasten

Projekt:
INNO EXPO, WS 15/16
Polaroid
Kerstin Schmuck



Projekt:
INNO EXPO, WS 15/16
Polaroid
Kerstin Schmuck

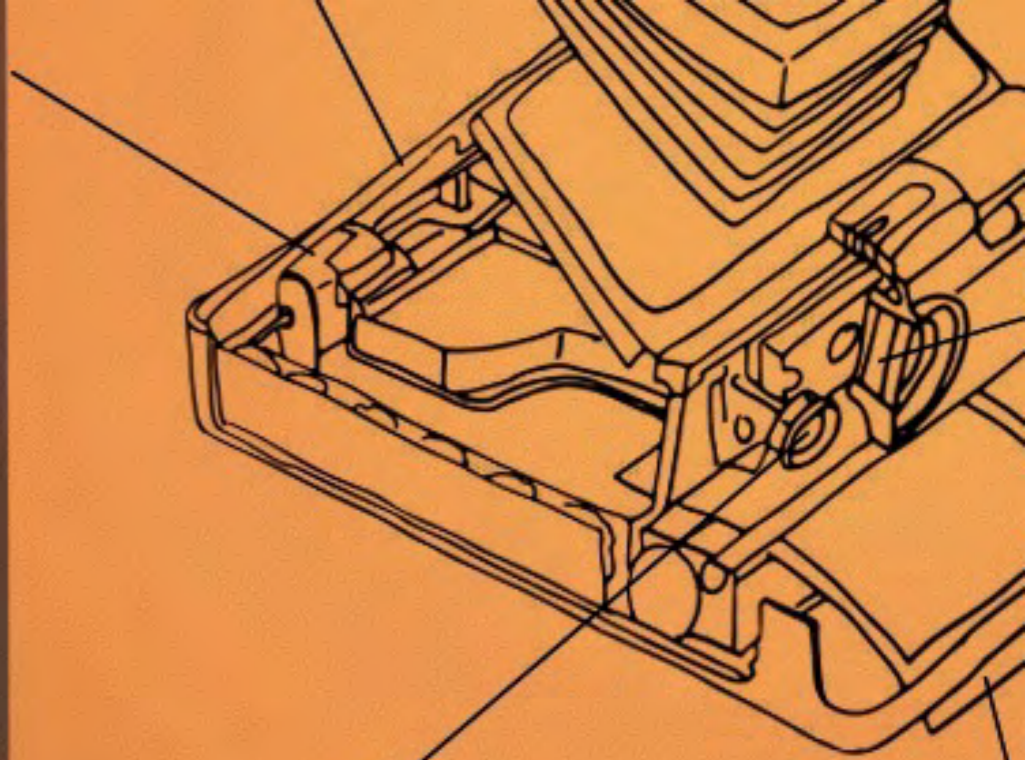

Auslöser
Knopf

Entw
v.

Projekt:
INNO EXPO, WS 15/16
Polaroid
Kerstin Schmuck

**I NEVER READ
I JUST LOOK
AT PICTURES**

Andy Warhol

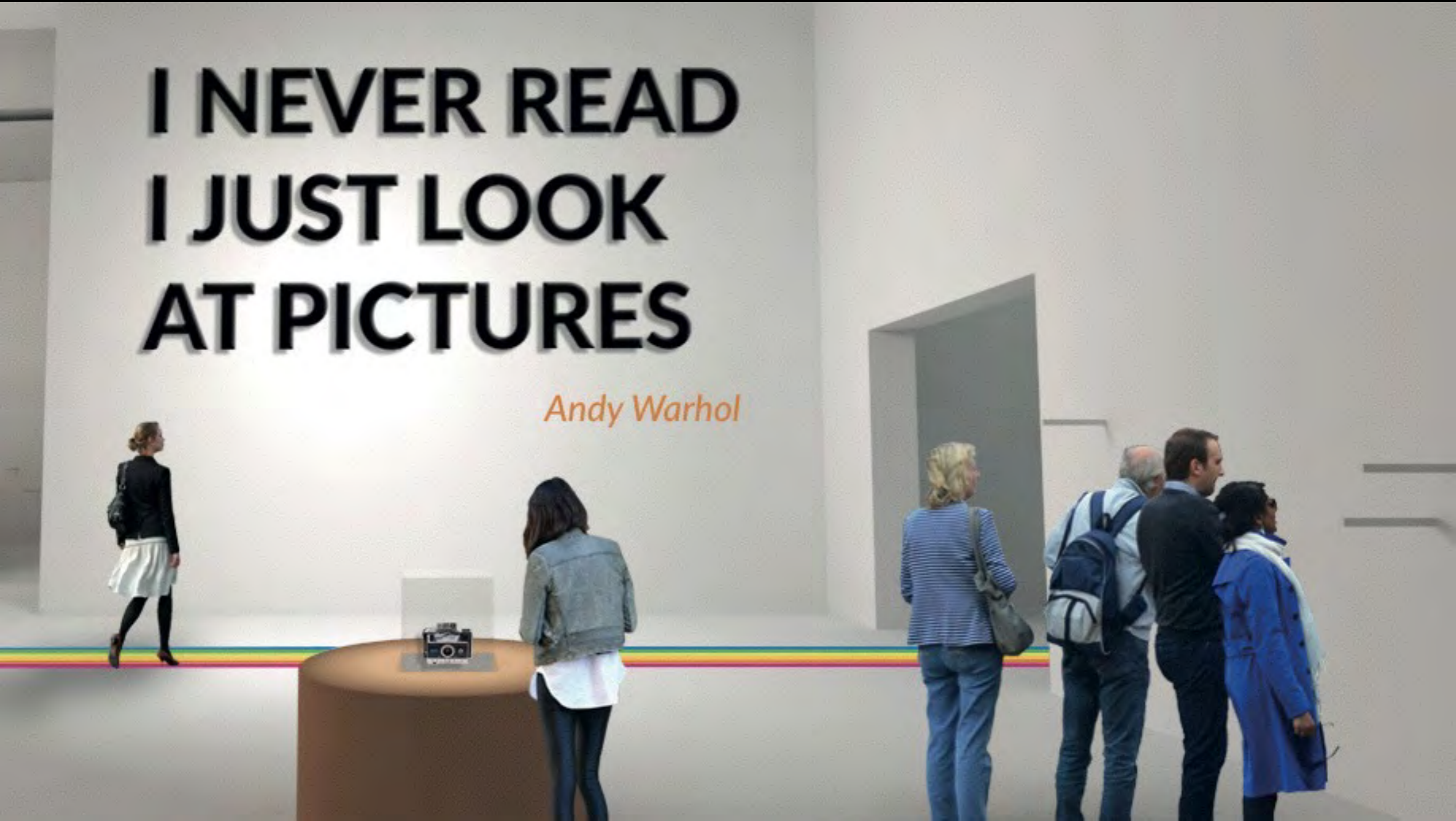

Projekt:
INNO EXPO, WS 15/16
Polaroid
Kerstin Schmuck





Projekt:
INNO EXPO, WS 15/16
Kaleidosclone
Christian Pichlkastner

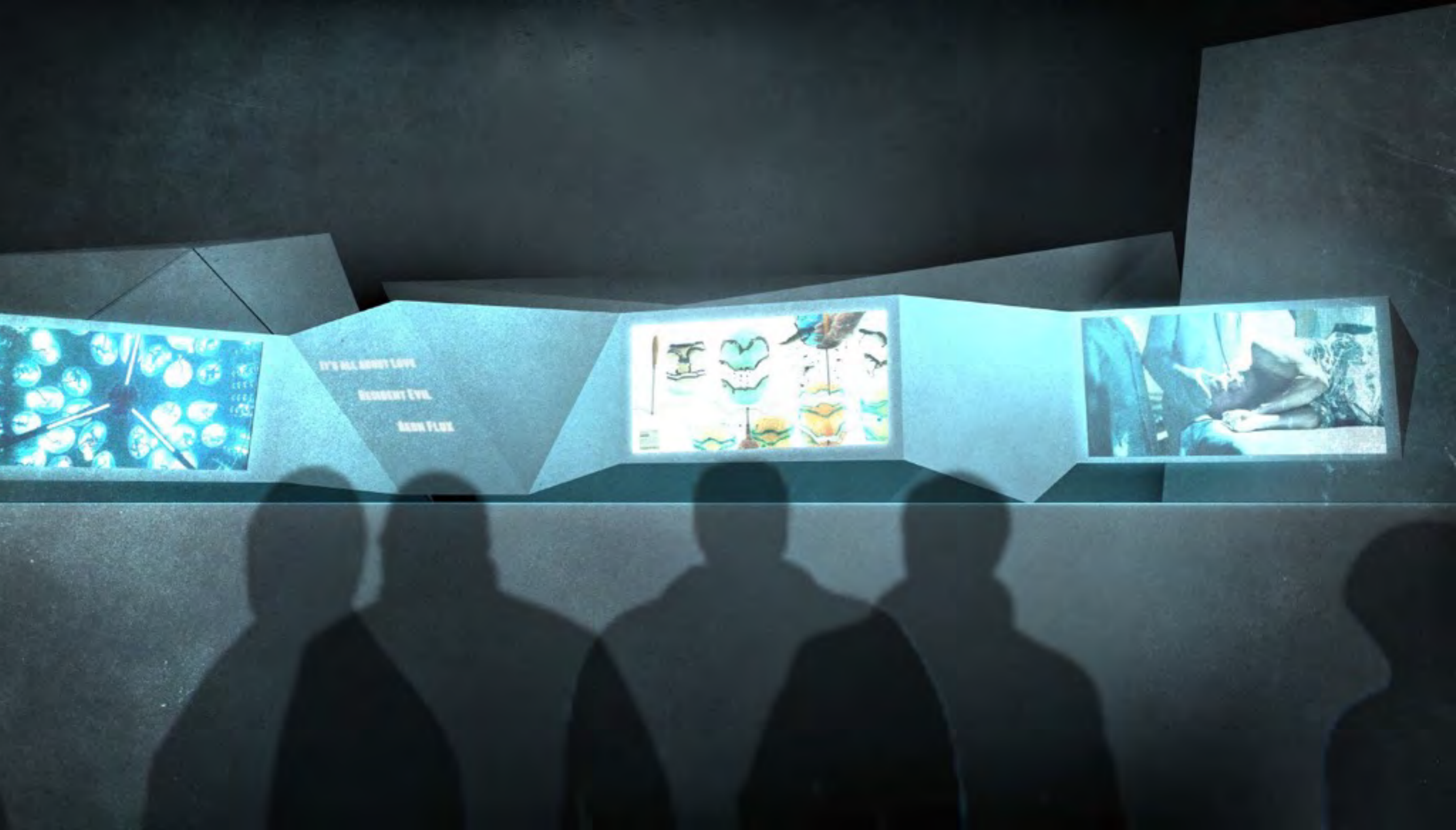

Projekt:
INNO EXPO, WS 15/16
Kaleidosclone
Christian Pichlkastner

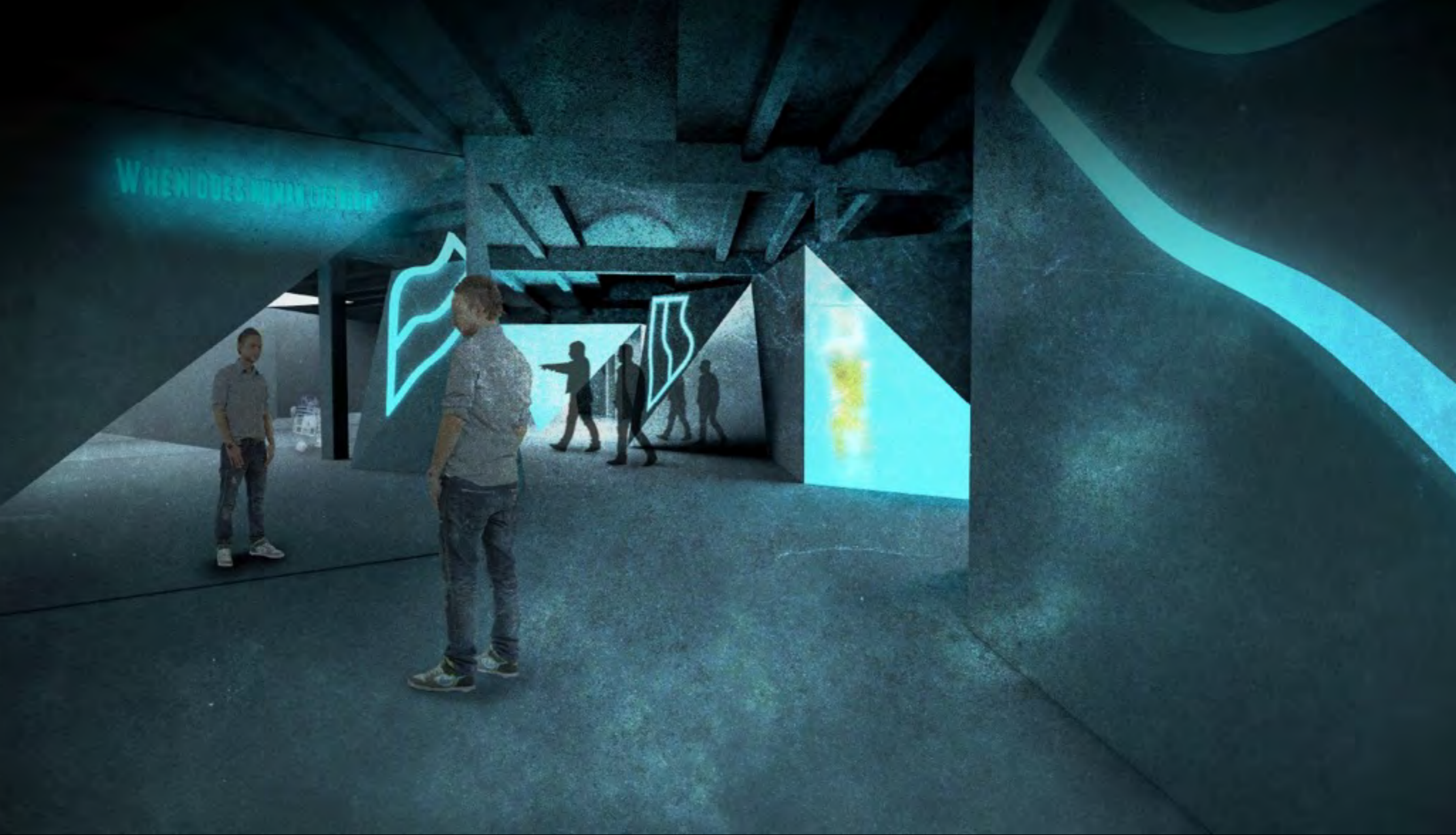

Projekt:
INNO EXPO, WS 15/16
Kaleidosclone
Christian Pichlkastner

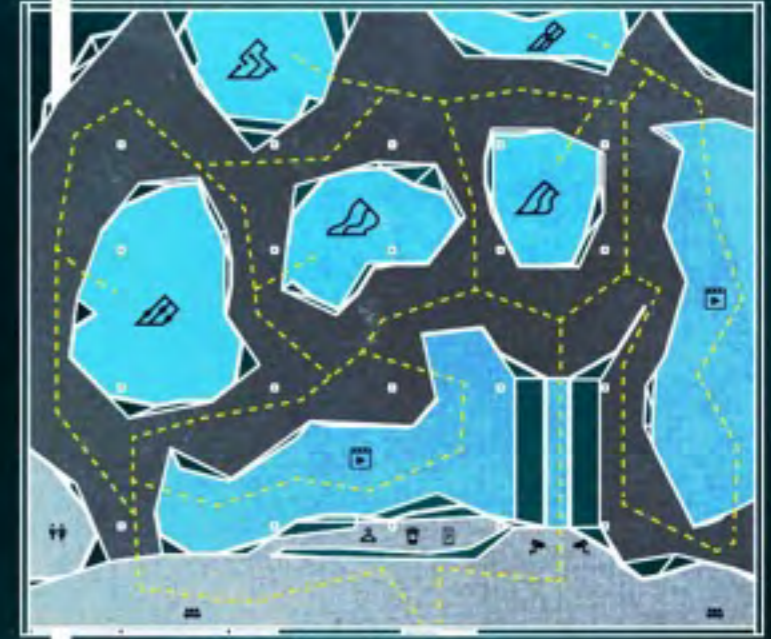

Projekt:

INNO EXPO, WS 15/16

Olfactory

David Dobestsberger

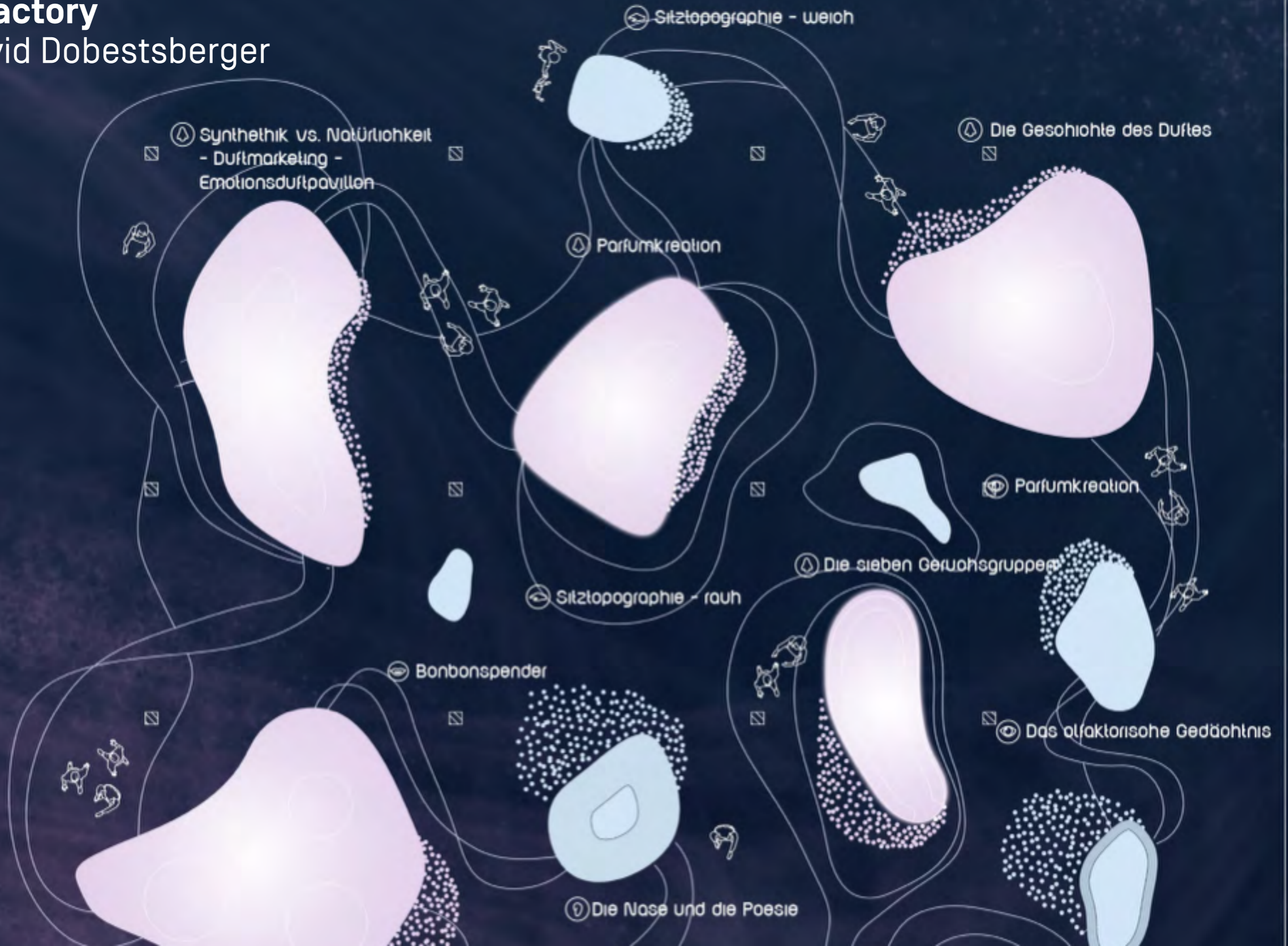

Projekt:
INNO EXPO, WS 15/16
Olfactory
David Dobestsberger

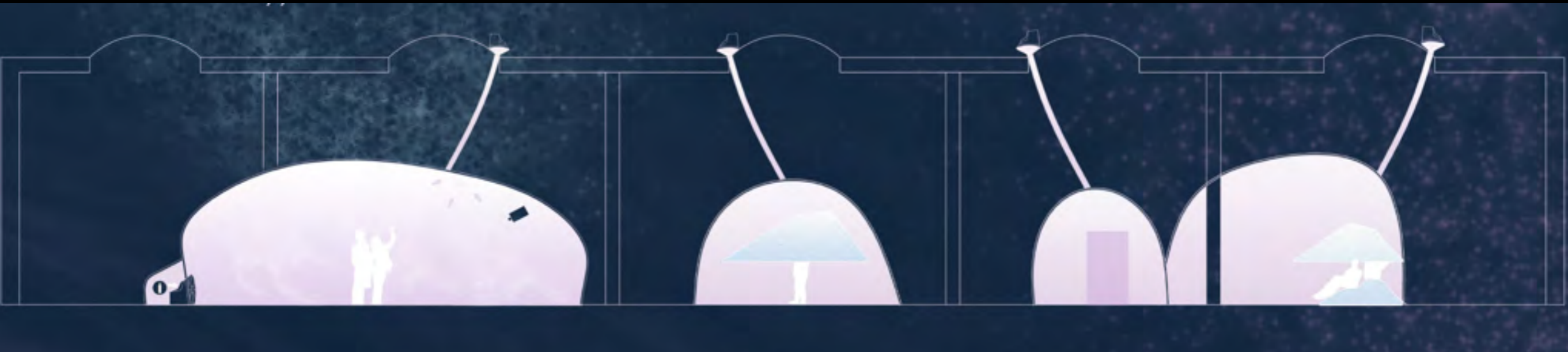



Projekt:
INNO EXPO, WS 15/16
Die Bionik des Flügelschlags
Katharina Sickha



Projekt:
INNO EXPO, WS 15/16
Die Bionik des Flügelschlags
Katharina Sickha

